



TAKE IT EASY.

Hitch Fitting Tips

ENSURING THE PERFECT FIT ON A HITCH RECEIVER

THINGS YOU WILL NEED:



FIRST

Determine Hitch Size and Weight Capacity

Our hitch racks are designed and tested to work in 50 mm (2") receivers.

Measure the opening of the receiver, or check the vehicle owner's manual under "Towing." Otherwise you can check with the dealership or manufacturer.

Weight Capacity: To determine the max capacity the carrier can hold on the specific vehicle, please review the vehicle owner's manual and/or towbar capacity plate for the maximum tow ball weight capacity.

Take the lower of the 2 values and subtract the carrier's weight. This will give you the maximum load the carrier can accept on the specific vehicle. This is capped by the carrier's maximum capacity.

Example 1:

The maximum tow ball weight capacity is 80 kg. The tow bar's maximum tow ball weight capacity is 120 kg. The carrier is weighing 23 kg. The lower value of the vehicle and towbar is the vehicle's 80 kg. $80 \text{ kg} - 23 \text{ kg}$ of the carrier = 57 kg max load capacity. The carrier's max capacity is 68 kg. **57 kg can be loaded on the carrier.**

Example 2:

The vehicle's maximum tow ball weight capacity is 160 kg. The towbar's maximum tow ball weight capacity is 350 kg. The carrier is weighing 23 kg. The lower value of the vehicle and towbar is the vehicle's 160 kg. $160 \text{ kg} - 23 \text{ kg}$ of the carrier = 137 kg max load capacity. The carrier's max capacity is 68 kg. **68 kg can be loaded on the carrier.**

NEXT

Use the Chart Below to Match Products

Use the chart on the back of this sheet to determine what products are compatible with your hitch receiver.

LAST

Follow Fit Measurements

Because hitch receivers can end up in different locations relevant to each vehicle manufacturer's shape, it is important to check the provided fit measurements for compatibility. Find the products that fit your receiver and locate the A,B,C,D and E measurements that associate with the product.

HITCH MEASUREMENTS						STRAIGHTSHOT HITCH EXTENDER	
PRODUCTS	A	B	C	D	E	B	C
OnRamp™ 2"	76 mm Min.	130 mm Max.	130 mm Max.	254 mm ★	38 mm Min.	184 mm	184 mm
HangOver™ 6	76 mm Min.	203 mm Max.	330 mm Max.	305 mm Min.	38 mm Min.	NA*	NA*
HangOver™ 4	76 mm Min.	203 mm Max.	330 mm Max.	254 mm Min.	38 mm Min.	184 mm	184 mm
BackSwing™	73 mm Min.	208 mm Max.	165 mm Max.	254 mm ★	38 mm Min.	NA*	NA*
HoldUp™ 2"	73 mm Min.	229 mm Max.	248 mm Max.	254 mm ★	38 mm Min.	184 mm	184 mm
HoldUp™ EVO 2"	76 mm Min.	127 mm Max.	216 mm Max.	254 mm ★	38 mm Min.	184 mm	184 mm
SingleSpeed™	41 mm Min.	197 mm Max.	304 mm Max.	254 mm ★	69.85 mm Min.	NA*	NA*
FullSwing™	76 mm Min.	222 mm Max.	171 mm Max.	254 mm ★	38 mm Min.	184 mm	184 mm
FourTimer™	70 mm Min.	340 mm Max.	368 mm Max.	254 mm ★	38 mm Min.	NA*	NA*
TwoTimer™	48 mm Min.	318 mm Max.	316 mm Max.	254 mm ★	50 mm Min.	184 mm	184 mm
LongHaul™	79 mm Min.	111 mm Max.	260 mm Max.	254 mm ★	38 mm Min.	184 mm	184 mm
BackRoad™	50 mm Min.	225 mm Max.	225 mm Max.	254 mm ★	38 mm Min.	NA*	NA*
DoubleDown™	50 mm Min.	232 mm Max.	229 mm Max.	254 mm ★	50 mm Min.	NA*	NA*
DoubleDown™ Ace 4&5	50 mm Min.	232 mm Max.	229 mm Max.	254 mm ★	50 mm Min.	NA*	NA*
LongArm™	70 mm Min.	216 mm Max.	254 mm Max.	254 mm ★	38 mm Min.	NA*	NA*
StageTwo 2"	76 mm Min.	136 mm Max.	216 mm Max.	254 mm ★	38 mm Min.	184 mm	184 mm

NOTES

MEASUREMENT A
An obstacle inside or behind the hitch can be present.

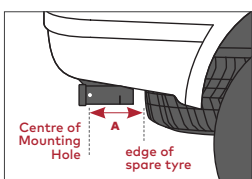
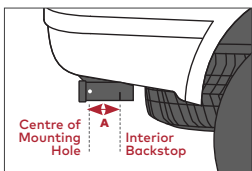

MEASUREMENT B
Make sure the bumper will not interfere with the hitch rack.

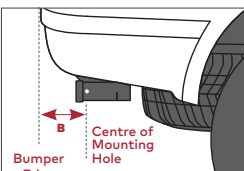

MEASUREMENT C
A spare-tyre may interfere with the install of a rack.

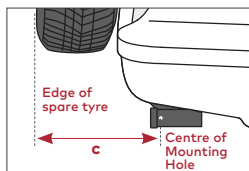

MEASUREMENT D

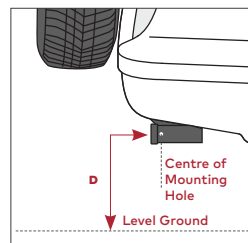

MEASUREMENT E

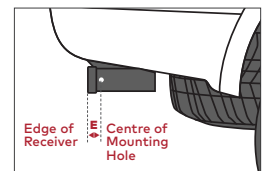

HITCH MEASUREMENTS

★ Measurement D is a recommended minimum on this product. Using Yakima Hitch mounted bike racks on vehicles with a pinhole to ground distance less than the minimum recommended increases the risk of the bikes or rack striking the ground while in use.

* NA - Not compatible and should not be used with the StraightShot hitch extension

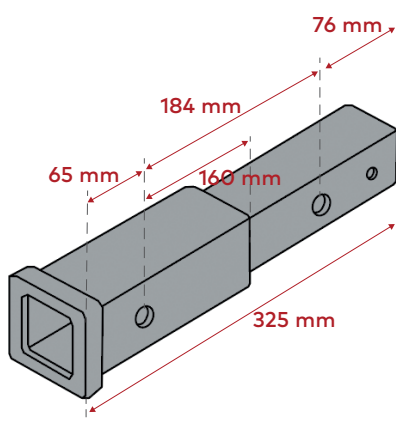

HITCH EXTENSION MEASUREMENTS

The hitch extension gives an additional 184 mm of clearance.

For models that come with hitch adapters, please ensure that the entire adapter is fully inserted into the hitch receiver.

Check for any limitations around short hitches. The maximum internal dimensions of the hitch receiver should be 52mm horizontal or vertical. Products may cause damage to, or detach from, a hitch receiver bigger than that.