

MAX ROOF BOX LOAD RATING: 75 kg

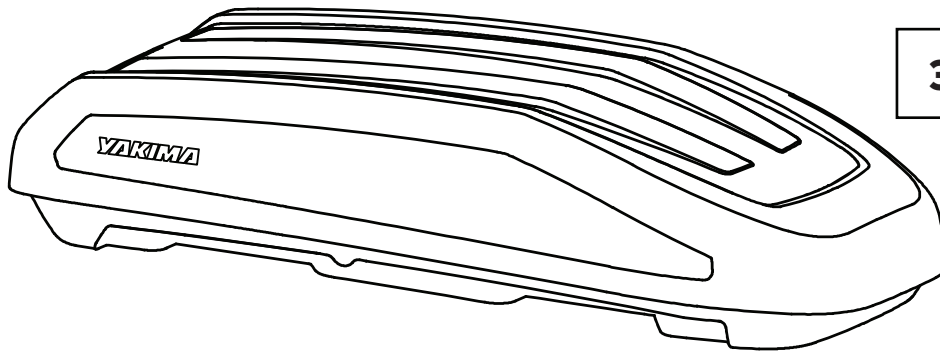

- TOTAL LOAD EQUALS WEIGHT OF ROOF RACK + ROOF BOX + CARGO
- PLEASE REFER TO VEHICLE MANUFACTURER SPECIFICATIONS FOR MAX ROOF LOAD CAPACITY OF VEHICLE. THE LOWEST LOAD RATING APPLIES.
- SCAN QR CODE FOR LOAD RATING GUIDE. REDUCTIONS MAY APPLY.



3 YEAR WARRANTY

IMPORTANT

- Check the contents of kit. Contact your YAKIMA dealer if any parts appear missing or damaged.
- It is critical that all work steps and safety notes indicated in these instructions for the initial assembly, mounting, remounting, use and handling of the roof box shall be strictly complied with.
- You are responsible for securing the racks and accessories to your car, checking the attachments prior to use, and periodically inspecting the products for adjustment, wear, and damage.
- If you do not understand all of the instructions and cautions, or if you have no mechanical experience and are not thoroughly familiar with the installation procedures, you should have the product installed by a professional installer.
- You are responsible for securing the roof box load correctly and safely.
- When transporting items on the roof, the relevant Road Traffic Regulations shall be followed.
- When driving with roof racks with and without load into garages, multistory car parks etc., it is imperative to observe the significantly increased vehicle height. Failure to comply may result in a collision and can lead to major material damage and personal injury.
- The roof box must be mounted in the direction of the travel without the leading edge tilted up, to avoid any increase in lifting forces.
- Place these instructions in the vehicle's glove box after installation is complete.

KIT CONTENTS

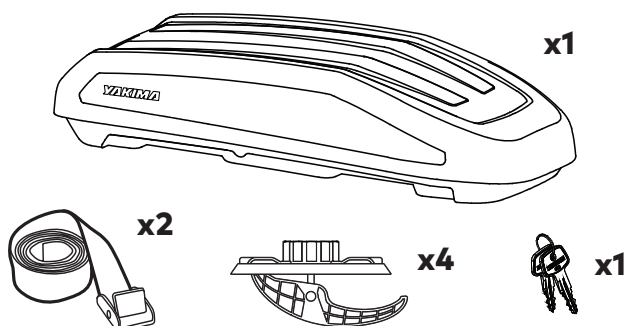

Specification	EasyTrip 400 L	EasyTrip 470 L	EasyTrip 550 L
	L 165 cm W 90 cm H 41 cm	L 186 cm W 90 cm H 43 cm	L 206 cm W 90 cm H 47 cm
	13.8 kg	16 kg	20 kg
	MAX 75 kg	MAX 75 kg	MAX 75 kg

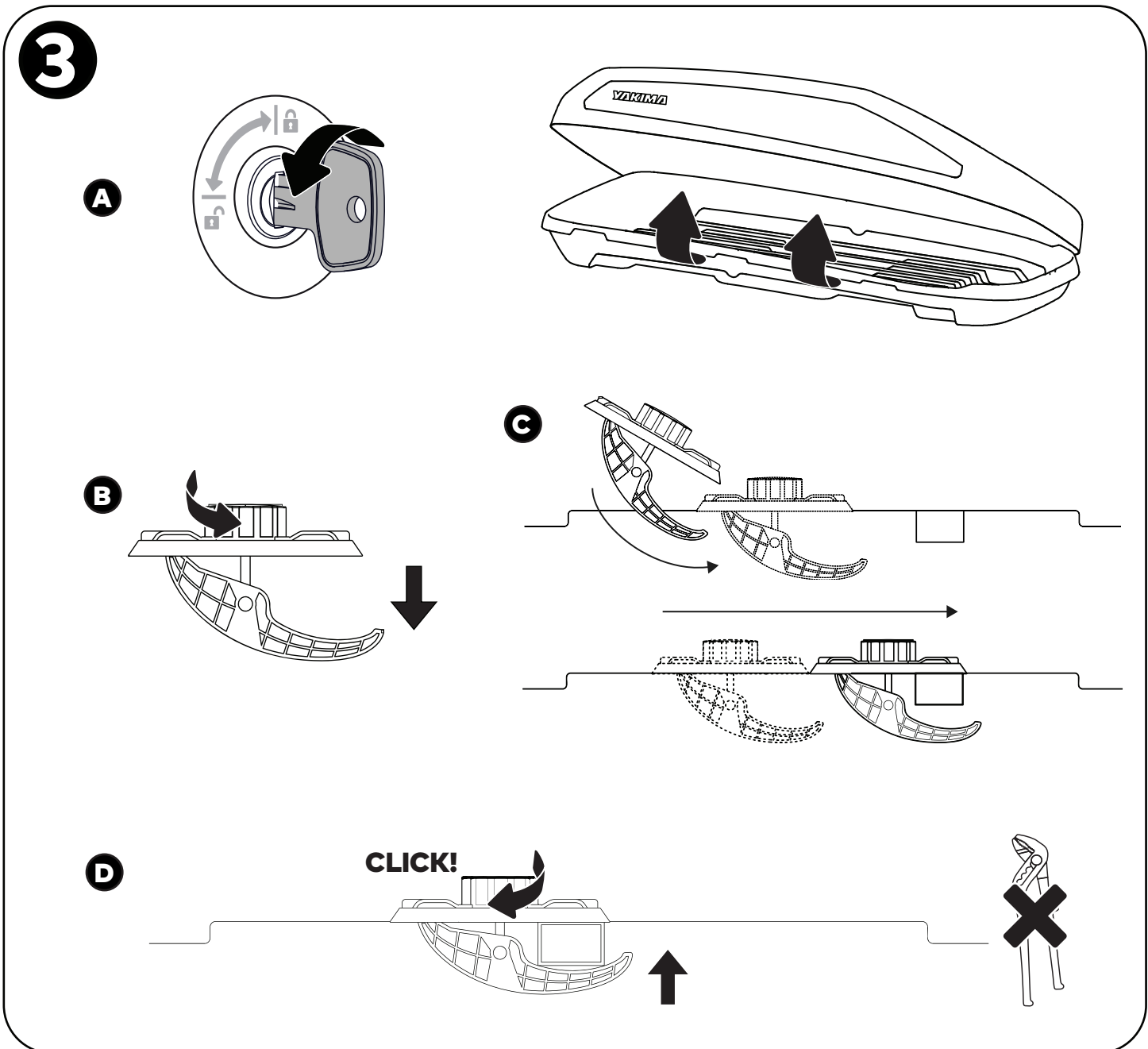
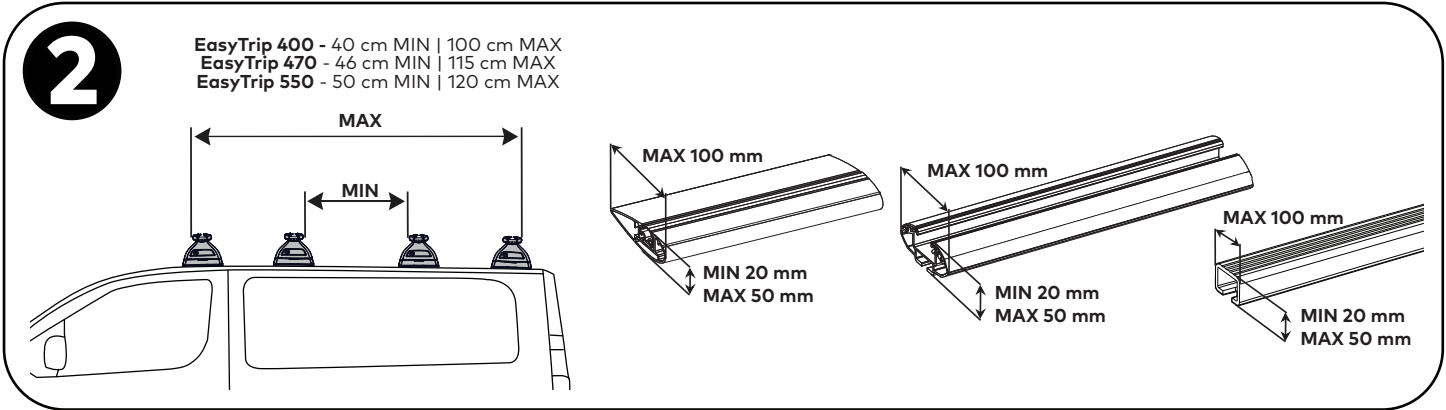
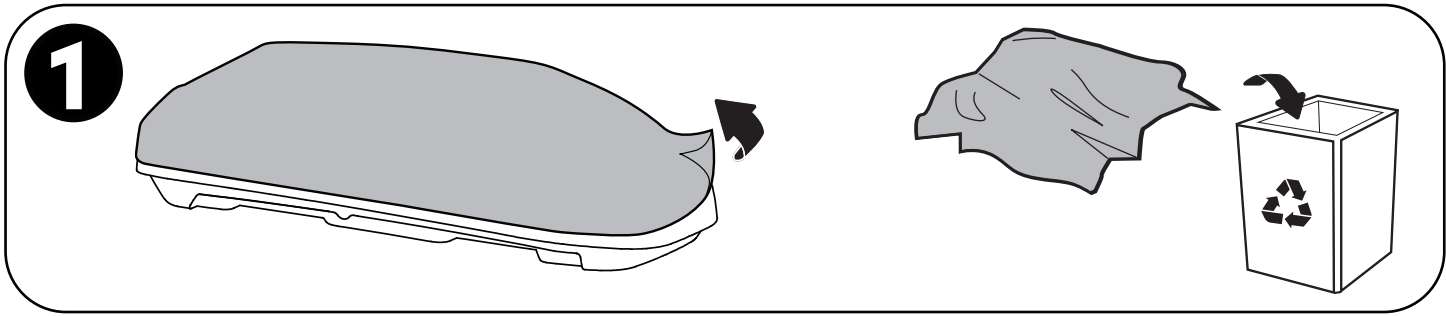

4

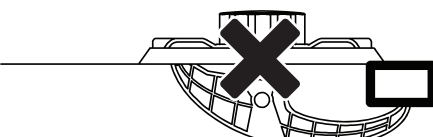
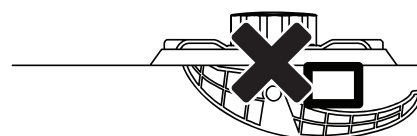
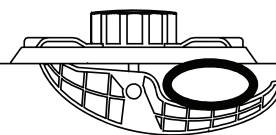
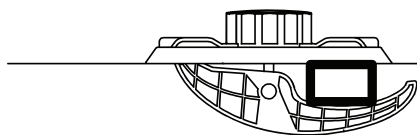
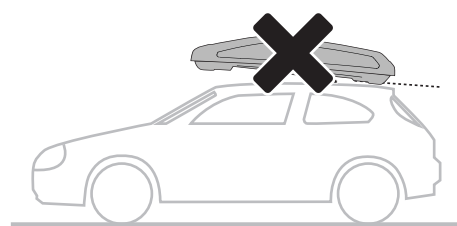
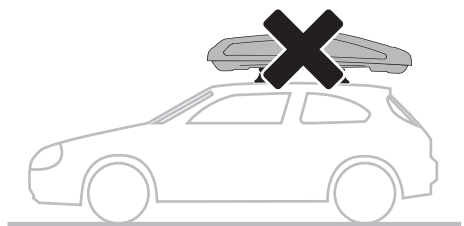
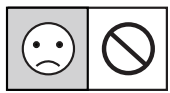
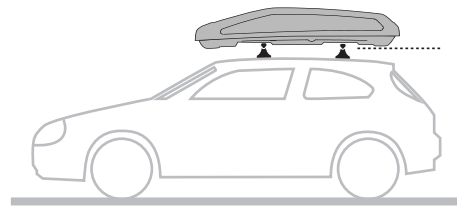
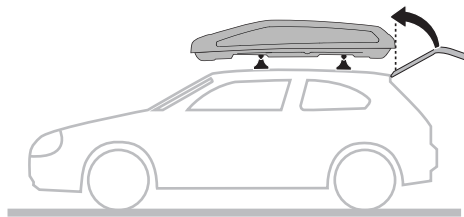
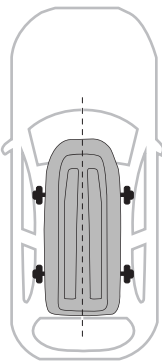

5

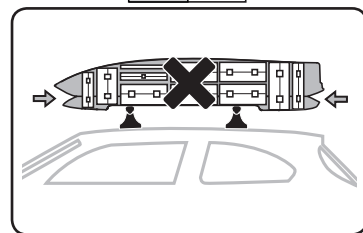
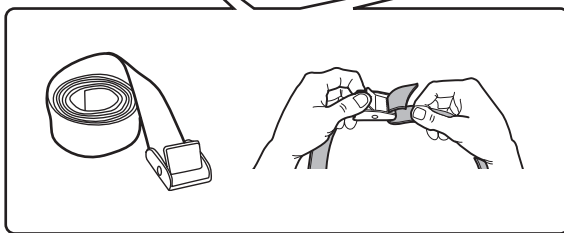
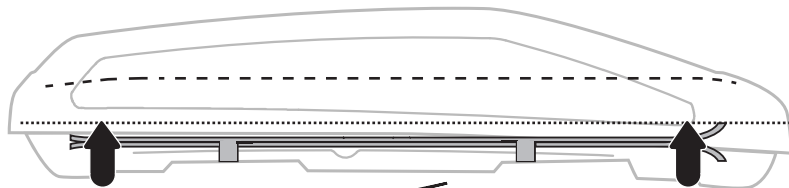
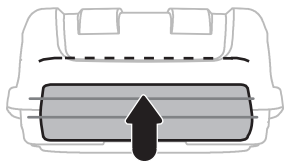
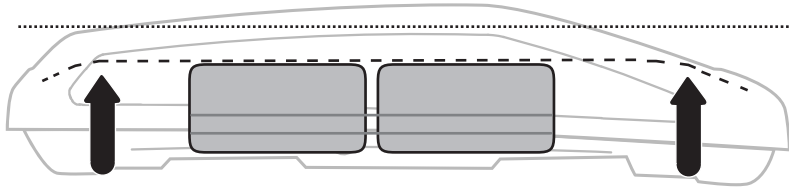
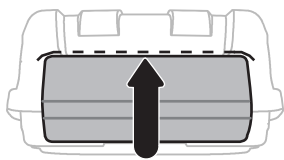
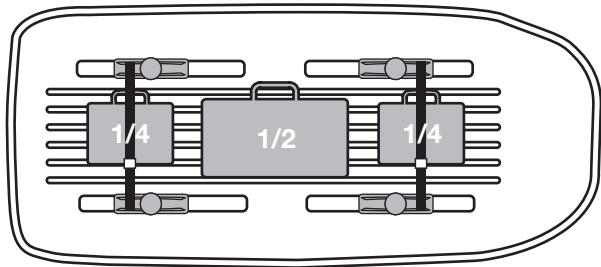
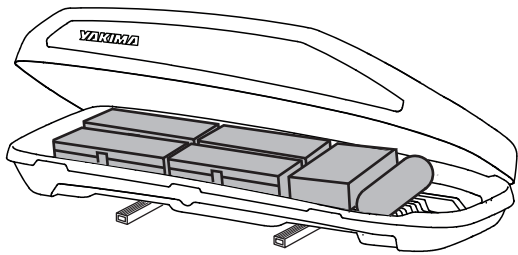

6

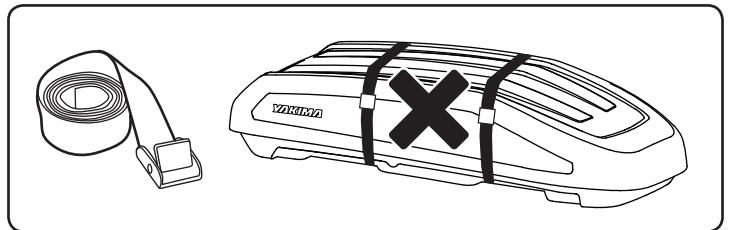
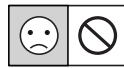
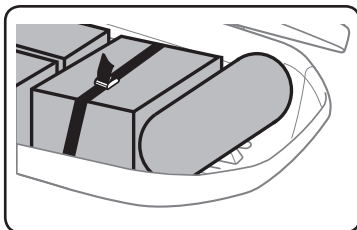
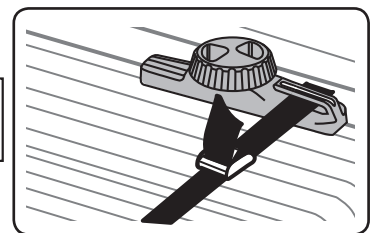
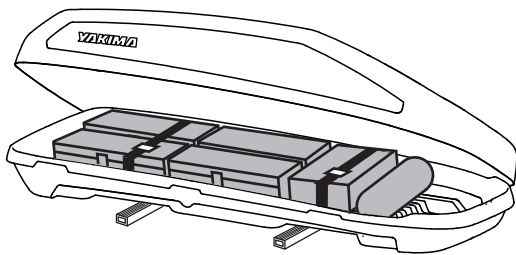

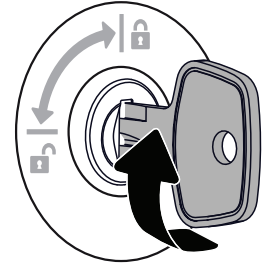
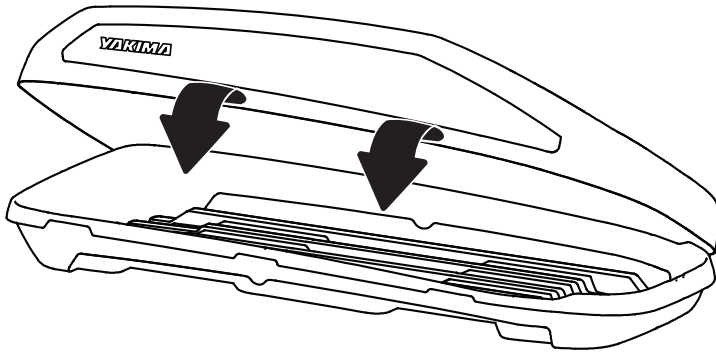
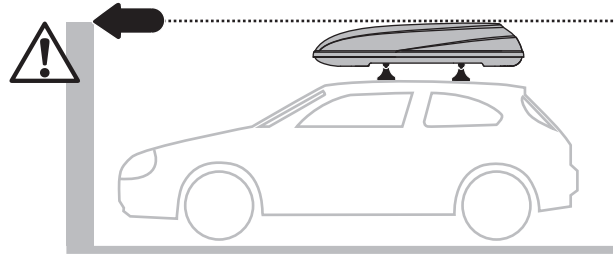
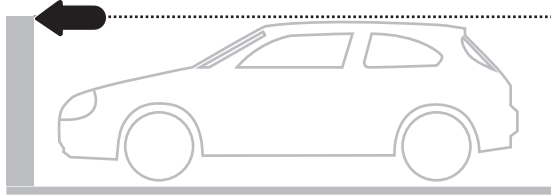
7**8**

CHANGING THE LOCK CORE

a

PRESS DOWN RED LUGS

Open lid of roof box. Locate the three red lugs on the inside of the base as shown. With the help of an assistant, press down all three red lugs while at the same time turn the key, locking the roof box.

NOTE - watch your fingers as locking the roof box engages a rod across the lugs.

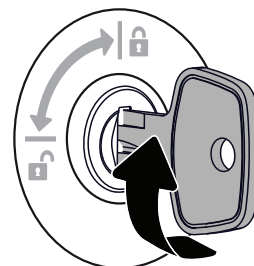
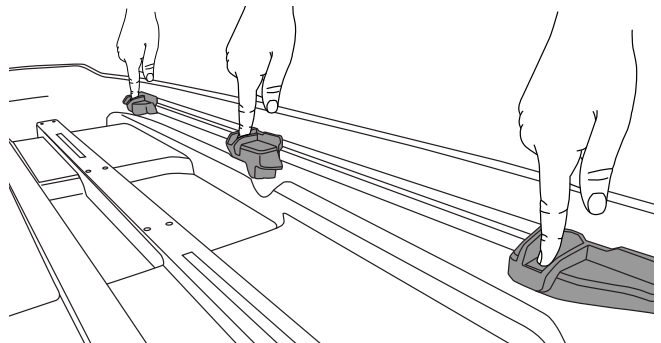
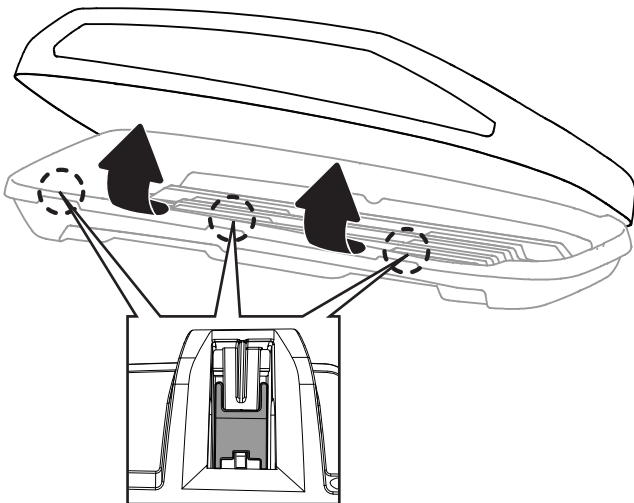

b**REMOVE LOCK CORE**

Using a 4 mm Allen key, insert the short end into the hole on the underside of the lock housing inside the roof box.

It can help to first feel with your finger the location of this hole before attempting to insert the Allen key.

While pressing the Allen key up into the hole, jiggle and pull out the core using the key, until it is completely removed.

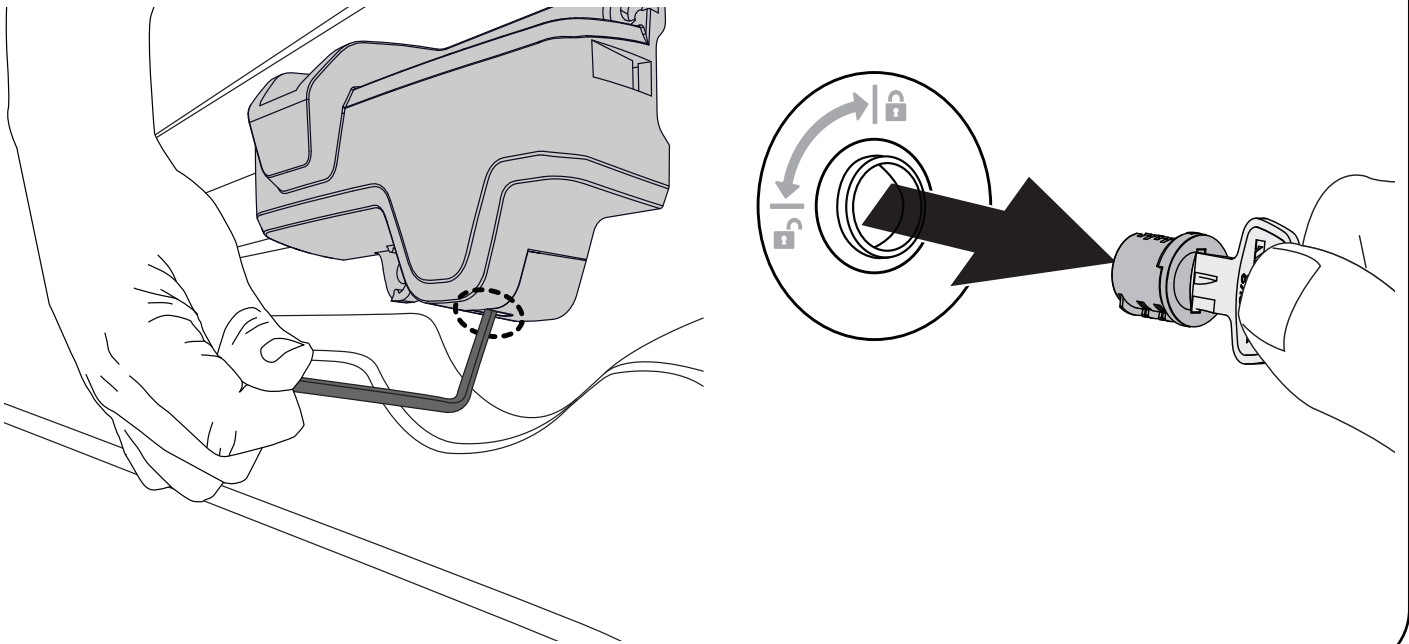
**c****INSERT NEW LOCK CORE**

Insert your new lock core with the metal tab facing downward.

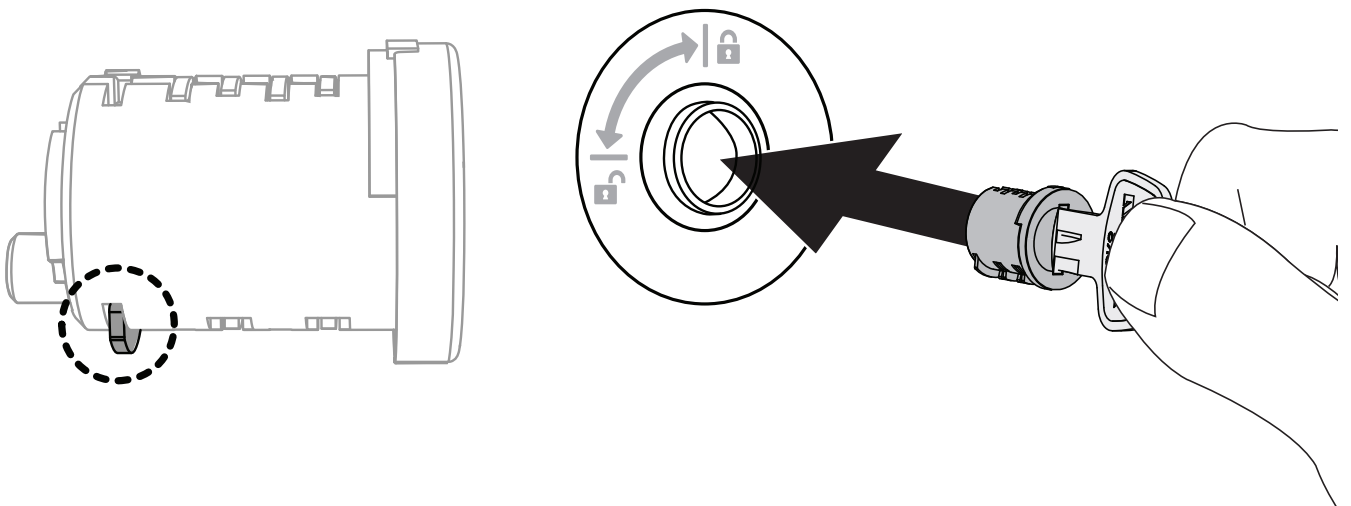

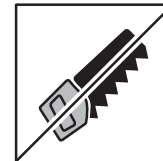
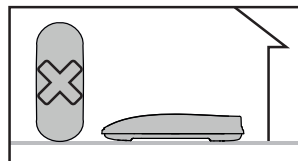
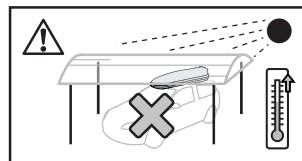
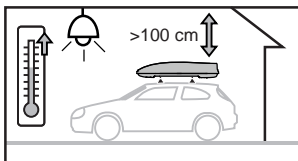
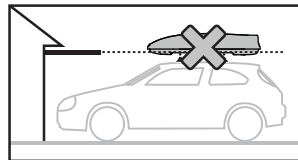
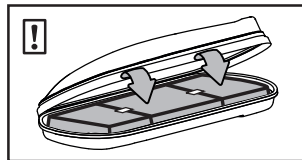
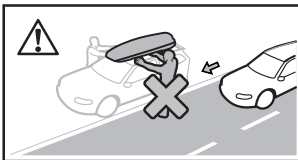
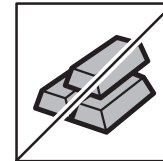
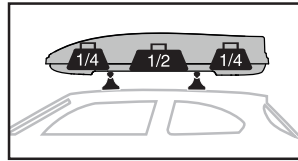
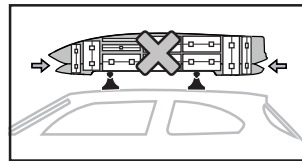
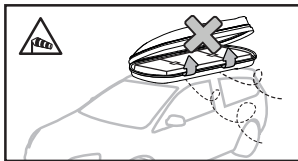
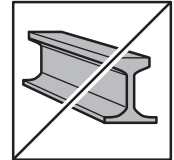
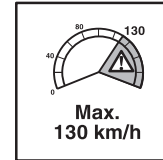
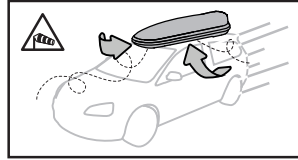
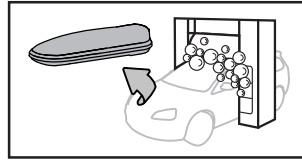
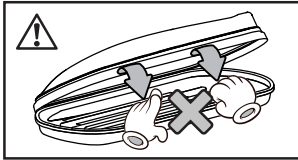
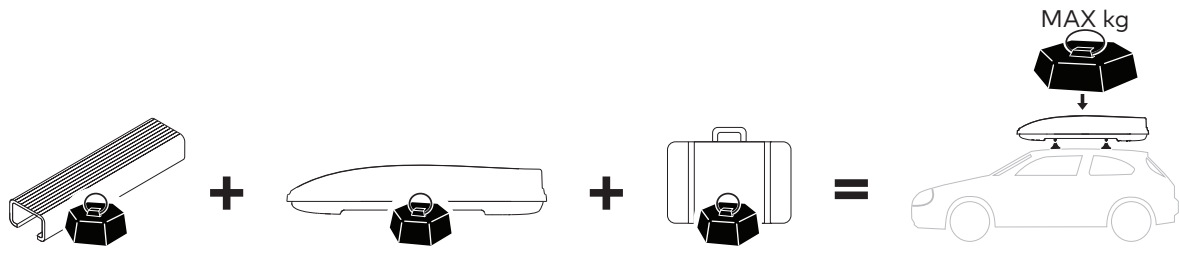

REQUIREMENTS AND RECOMMENDATIONS

- These instructions shall be handed over to other users if handing over the roof box.
- The roof box is designed so that no damage to the vehicle can result after proper assembly and use.
- After a short travel at first and specific time periods (maximum 30 minutes on rough road or 50 km on normal), the bolt connections and the roof box fixing have to be checked and retightened, if necessary.
- After driving breaks, in which the vehicle with roof accessories has been left unattended, all freely accessible attachments of the roof accessories and the load should be checked for strength and functionality (inspection for damaging external influence).
- Distribute the luggage items evenly, keep the centre of gravity as low as possible and secure the transport strap against moving out of place with suitable tensioning straps (no elastic straps).
- Note that the driving performance changes depending on the load transported.
- Sudden braking, abrupt starting off and rapid cornering shall be avoided where possible.
- The speed shall be adapted to the objective conditions such as road state, road surfacing, side wind conditions, general traffic levels etc.
- For reasons of fuel economy and the safety of other road users, roof accessories should be removed from the vehicle when not in use.
- Do not drive into car washes with mounted roof boxes.



www.yakima.com.au
www.yakima.co.nz
www.yakima.com
www.yakima.eu

YAKIMA AUSTRALIA PTY LTD

17 Hinkler Court
Brendale, QLD 4500
Australia
1800 143 548

YAKIMA PRODUCTS, INC.

4101 Kruse Way
Lake Oswego, OR
97035-2541
USA
888 925 4621
yakima.com/support